

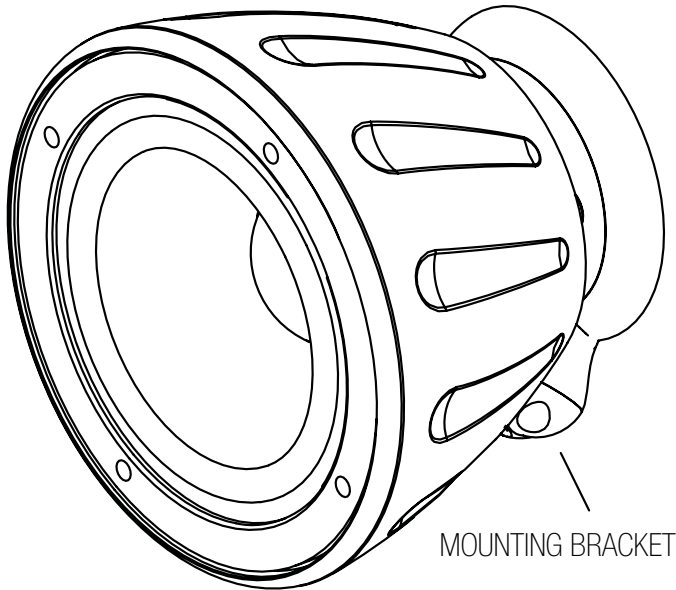

# [SOLARIS<sup>®</sup>] [outdoor series] SPF-15

## OWNER'S MANUAL & INSTALL GUIDE

**FULL-RANGE SURFACE-MOUNT OUTDOOR SPEAKER**



**[BOX CONTENTS]**  
**1 SPEAKER**

Thank you for choosing Phase Technology<sup>®</sup> speakers. We know there are a wide variety of choices available today, and we sincerely appreciate your purchase of our product. Phase Technology speakers are built to exacting standards and will provide many years of listening enjoyment.

Our speakers are the result of over five decades of designing and manufacturing. We hold many key patents in loudspeaker technology including the soft-dome tweeter. Our mission, our passion is to constantly advance the art and science of accurate audio reproduction. Our dedication insures your new speakers will accurately reproduce all the impact, detail and delicacy of today's digital technology.

Regardless of application, serious audiophile listening or home theater, we recommend that you take the time to read this manual thoroughly before connecting speakers to your amplifier or receiver. In the highly unlikely event that you should experience a problem with set-up or operation, please contact one of our authorized dealers for assistance, or contact us directly.

Phase Technology Corporation  
8005 W. 110th St., Suite 208  
Overland Park, KS 66210  
855.663.5600 (Domestic)  
+1.913.663.5600 (International)  
Fax: 913.663.3200

**[OPTIONAL ACCESSORY: AC-SPF-MP]  
(SOLD SEPARATELY)**

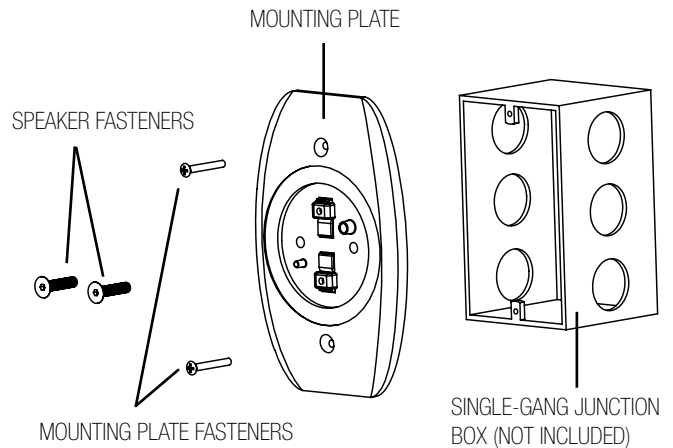

**[BOX CONTENTS FOR AC-SPF15-MP]**  
**1 MOUNTING PLATE**  
**2 FASTENERS FOR SPEAKER TO WALL PLATE**  
**2 FASTENERS FOR WALL PLATE TO JUNCTION BOX**

**\*\*JUNCTION BOX REQUIREMENTS\*\***

NEW CONSTRUCTION JUNCTION BOX REQUIRED. UNIT WILL **NOT** FIT IN RETROFIT-STYLE JUNCTION BOX. PHASE TECHNOLOGY RECOMMENDS TESTING FIT BEFORE INSTALLING JUNCTION BOX.

<b>SAFETY INSTRUCTIONS</b>	<b>3</b>
<b>GETTING STARTED AND PRECAUTIONARY NOTES</b>	<b>4</b>
<b>CARING FOR YOUR SPEAKERS</b>	<b>4</b>
<b>MAINTENANCE AND SERVICE</b>	<b>4</b>
<b>INSTALLATING YOUR SPF-15</b>	<b>4</b>
<b>INSTALLATING YOUR SPF-15 USING AC-SPF15-MP</b>	<b>5</b>
<b>WARRANTY</b>	<b>5</b>
<b>SPECIFICATIONS</b>	<b>5</b>

## [SAFETY INSTRUCTIONS]

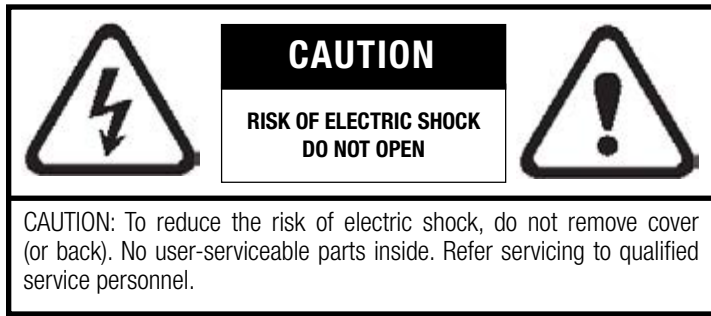

### Explanation of Graphical Symbols



The lightning flash with arrowhead symbol, within an equilateral triangle, is intended to alert you to the presence of un-insulated "dangerous voltage" within the product's enclosure that may be of sufficient magnitude to constitute a risk of electric shock to persons.



The exclamation point within an equilateral triangle is intended to alert you to the presence of important operating and maintenance (servicing) instructions in the literature accompanying the appliance.

**1. Read Instructions** - All the safety and operating instructions should be read before the appliance is operated.

**2. Retain Instructions** - The safety and operating instructions should be retained for future reference.

**3. Heed Warnings** - All warnings on the appliance and in the operating instructions should be adhered to.

**4. Follow Instructions** - All operating and other instructions should be followed.

**5. Water and Moisture** - The appliance should not be used near water - for example, near a bathtub, washbowl, kitchen sink, laundry tub, in a wet basement, or near a swimming pool, etc.

**6. Carts and Stands** - The appliance should be used only with a cart or stand that is recommended by the manufacturer.

### PORTABLE CART WARNING



**7. Wall or Ceiling Mounting** - The appliance should be mounted to a wall or ceiling only as recommended by the manufacturer.

**8. Ventilation** - The appliance should be situated so that its location or position does not interfere with its proper ventilation. For example, the appliance should not be situated on a bed, sofa, rug, or similar surface that may block the ventilation openings; or placed in a built-in installation, such as a bookcase or cabinet

that may impede the flow of air through the ventilation openings.

**9. Heat** - The appliance should be situated away from heat sources such as radiators, stoves, or other appliances that produce heat.

**10. Power Source** - The appliance should be connected to a power supply only of the type described in the operating instructions or as marked on the appliance.

**11. Power Cord Protection** - Power supply cords should be routed so that they are not likely to be walked on or pinched by items placed up or against them, paying particular attention to cords at plugs, convenience receptacles, and the point where they exit from the appliance.

**12. Cleaning** - The appliance should be cleaned only as recommended by the manufacturer.

**13. Nonuse Periods** - The power cord of the appliance should be unplugged from the outlet when left unused for a long period of time.

**14. Object and Liquid Entry** - Care should be taken so that neither objects fall nor liquids spill into the inside of the appliance.

**15. Damage Requiring Service** - The application should be serviced by qualified service personnel when:

- the power supply cord or the plug has been damaged,
- objects have fallen onto or liquid has been spilled into the appliance,
- the appliance has been exposed to rain,
- the appliance does not appear to operate normally or exhibits a marked change in performance, or
- the appliance has been dropped or the cabinet damaged.

**16. Servicing** - The user should not attempt to service the appliance beyond those means described in the operating instructions. All other servicing should be referred to qualified service personnel.

**17. Grounding or Polarization** - Precautions should be taken so that the grounding or polarization means of an appliance is not defeated.

**APPLICABLE FOR USA, CANADA OR WHERE APPROVED FOR USAGE**

**CAUTION: TO PREVENT ELECTRIC SHOCK, MATCH WIDE BLADE PLUG TO WIDE SLOT, INSERT FULLY.**

**ATTENTION: POUR EVITER LES CHOCS ELECTRIQUES, INTRODUIRE LA LAME LA PLUS LARGE DE LA FICHE DANS LA BORNE CORRESPONDANTE DE LA PRESE ET POUSSER JUSQU'AU FOND.**

## [GETTING STARTED AND PRECAUTIONARY NOTES]

For proper connection and therefore full enjoyment of your new Phase Technology speakers, we encourage you to read this owners' manual thoroughly, even if you are very familiar with installing speakers.

Speaker placement is very subjective. When deciding upon a location, consider the following:

Make certain your speaker wires can be run to or are accessible from these locations. Make certain the wall or ceiling material is sturdy enough to support the weight and vibration of the speakers. Make certain the area behind the speaker is free of obstacles such as wallstuds, electrical wiring, pipes, etc. Each speaker should be positioned properly, relative to the listening area for good coverage.

## [CARING FOR YOUR PHASE TECHNOLOGY SPEAKER]

All Phase Technology speakers are finished with a high degree of craftsmanship in either hand polished paint or vinyl laminates. We recommend using a lint-free rag with a small amount of glass cleaner to maintain the long-lasting beauty of the finish. Avoid products containing silicones, oils, oil derivatives, or solvents. Enclosures finished in vinyl laminates may be cleaned with a damp cloth as necessary.

## [MAINTENANCE AND SERVICE]

Because of Phase Technology's uncompromising quality control programs, it's unlikely that your speakers will ever need service if connected and used as outlined in this Owners' Manual. In the unlikely event that a problem does occur, please contact your Phase Technology dealer. Your dealer has the necessary factory-authorized parts and trained technicians to quickly restore your speaker to its original performance specifications.

## [INSTALLING YOUR SPF-15]

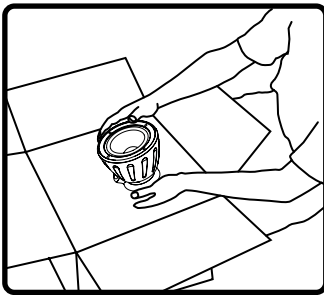

1. Unpack speaker.

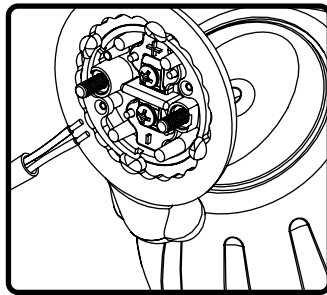

2. Connect speaker wire leads to the terminal screws on the back of the base plate. Polarity is indicated.

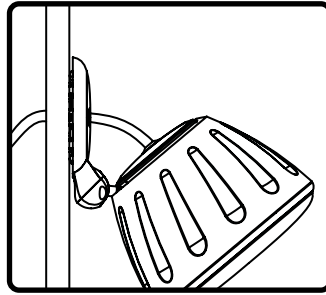

3a. If mounting the speaker directly over the wire, ensure the base plate covers the hole in wall.

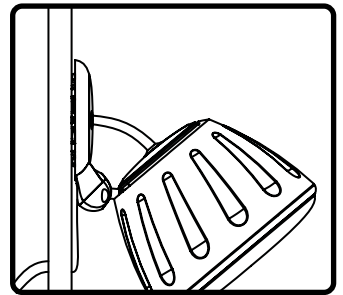

3b. If mounting speaker offset from wiring point, run wire out hole in wall and behind base plate through 2 mm standoff gap between base plate and wall. The standoff gap accepts up to 18 gauge flat signal wire.

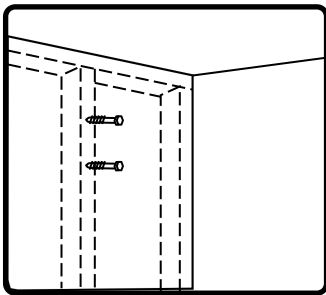

4. Choose a secure mounting surface with sufficient strength to reliably hold the speaker.

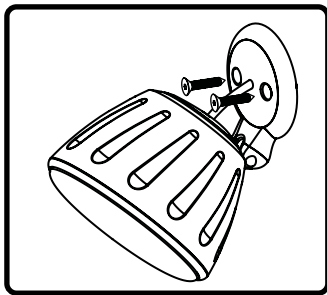

5. Attach speaker to surface using installer-supplied fasteners.

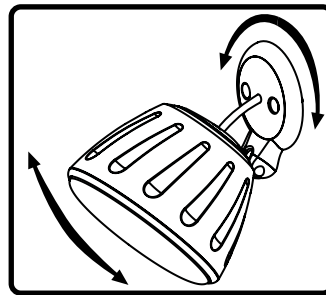

6. Aim speaker by pointing it up or down and/or rotating it.

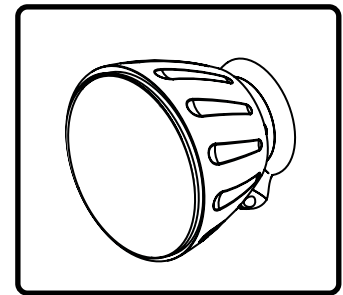

7. DONE!

**[INSTALLING YOUR SPF-15 USING AC-SPF15-MP]** Note: The AC-SPF15-MP will only fit into a single-gang new construction junction box (will not fit in retrofit style junction box).

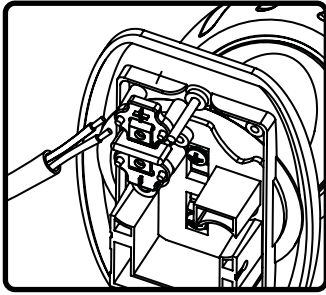

1. Attach signal wire to terminal strip. For daisy chaining, attach additional wires to positive and negative inputs.

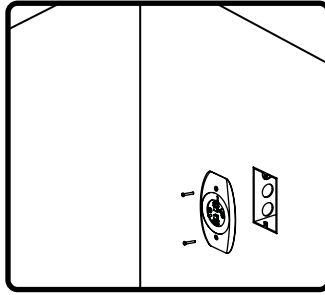

2. Install the AC-SPF15-MP into the installer-supplied junction box using included fasteners.

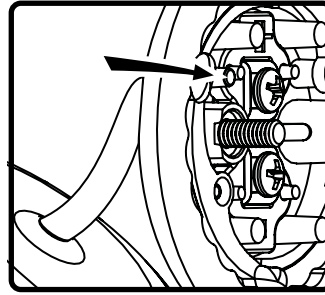

3. The base is keyed to ensure proper polarity. Be sure smaller post on rear of SPF-15 connects to polarity key on wall plate. Both are marked for easy identification.

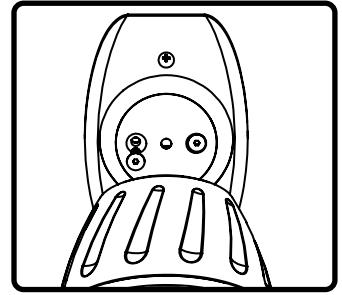

4. Attach speaker to mounting plate with supplied fasteners. No wiring is necessary because signal wire contact is made when speaker is screwed in place.

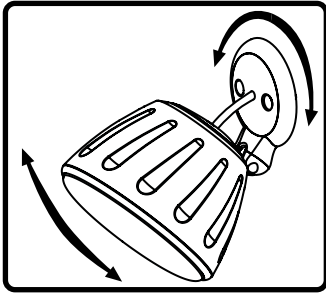

1. To aim the speaker, rotate it using the ball and base plate to point in any direction.

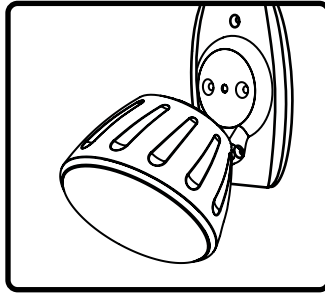

2. DONE!

**[WARRANTY]**

**LIMITED WARRANTY:** Phase Technology warrants its loudspeakers to be free from defects in material and workmanship for a period of ten (10) years for speaker product, limited lifetime for CI speakers, and three (3) years for the electronic components to the original purchaser. Purchase must be made from an authorized Phase Technology dealer.

This warranty does not cover service or parts to repair damage caused by misuse, abuse, damage while in transit, alterations, unauthorized repairs, failure to follow instructions, fire, flood or any other cause beyond the reasonable control of Phase Technology. Defects in speaker cabinets or grilles must be brought to the attention of your dealer immediately after purchase. This warranty will be void if the products' serial number has been altered or removed.

Should your Phase Technology product require service, please call the MSE Audio customer service department for a return authorization. All merchandise returned to Phase Technology without prior authorization will be refused. For your return authorization number, please call 855.663.5600 or email sales@mseaudio.com.

**[SPECIFICATIONS]**

	<b>SPF-15</b>	
	<b>Tweeter:</b>	N/A
	<b>Woofers:</b>	3" Polypropylene w/ NBR Surround
	<b>Recommended Power (RMS)</b>	10 - 60 W
	<b>Frequency Response:</b>	120 Hz-22 kHz
	<b>Sensitivity:</b>	85 dB
	<b>Impedance:</b>	8Ω
	<b>Crossover Frequency:</b>	3 kHz
	<b>Dimensions:</b>	4.35" Diameter x 3.81" Depth (with mounting bracket)
	<b>Weight:</b>	1.4 lbs.
	<b>Grille:</b>	Paintable Powder-Coated Aluminum
	<b>Finish Options:</b>	Paintable White and Paintable Black
	<b>Certifications:</b>	UL 1480 Listed
	<b>Optional Accessories:</b>	Mounting Plate (AC-SPF15-MP)

Copyright © 2014 MS Electronics, LLC. All rights reserved. MSE Audio, Phase Technology and PhaseTech are registered trademarks and "Speakers for your Life" is a trademark of MSE Audio, Overland Park, Kansas USA. Phase Technology is part of MSE Audio®. www.phasetech.com.

**MSE AUDIO** [  **INDUCTION DYNAMICS** [  **PHASE TECHNOLOGY**  *Rockustics* Solid|Drive® **SOUNDTUBE** ENTERTAINMENT **SOUNDSPHERE** LOOSPEAKERS ] ]  
www.mseaudio.com | 8005 W. 110th Street | Suite 208 | Overland Park, KS 66210 | p:913.663.5600 | f:913.663.3200